

OWNER'S/ OPERATOR'S MANUAL

**MODEL NO.
FOH-5**

⚠ CAUTION

For Safe Operation
Read Rules And
Instructions Carefully

SINO LEEINGLES, PIDA AYUDA
A AIGUIEN QUE SI LO LEA
PARA QUE LE TRADUZCA LAS
MEDIDAS DE SEGURIDAD.



FLIP-OVER SPIKE-TOOTH HARROW

**Safety Instructions
Tractor Preparation
Operating Instructions**

**Assembly & Mounting
Maintenance
Repair Parts**

⚠ CAUTION ⚠

**THE FOLLOWING SAFETY PRECAUTIONS SHOULD BE THOROUGHLY UNDERSTOOD
BEFORE ATTEMPTING TO BEGIN ASSEMBLING THIS MACHINE**

1. Select an area for assembly that is clean and free of any debris which might cause persons working on the assembly to trip.
2. Do not lift heavy parts or assemblies. Use crane, jack, tackle, fork trucks or other mechanical devices.
3. Preview the assembly instructions in your operator's manual before proceeding further.
4. If the assembly instructions call for parts or assemblies to be blocked up, use only blocking material that is in good condition and is capable of handling the weight of the assembly to be blocked. Also insure that the blocking material is on a clean, dry surface.
5. Never put hands, or any part of body, under blocked up assemblies if at all possible.
6. After completing assembly, thoroughly inspect the machine to be sure that all nuts, bolts, hydraulic fittings or any other fastened assemblies have been thoroughly tightened.
7. Before operating the machine, thoroughly read the operation section of your operator's manual.
8. Before operating, read the maintenance section of your operator's manual to be sure that any parts requiring lubrication, such as gearboxes, are full, to avoid any possible damage.
9. **Before operating equipment – If you have any questions regarding the proper assembly or operation, contact your dealer or representative.**

TABLE OF CONTENTS

WARRANTY	2
SAFETY INFORMATION	3
SAFETY SIGNS	8
PREPARATION INSTRUCTIONS	9
OPERATING INSTRUCTIONS	11
OWNER SERVICE & LUBRICATION	12
PARTS LISTS	13

SINO LEEINGLES, PIDA AYUDA A AIGUIEN QUE SI LO LEA PARA QUE LE TRADUZCA LAS MEDIDAS DE SEGURIDAD.

STATEMENT OF POLICY

It is the policy of Worksaver to improve its products where it is possible and practical to do so. Worksaver reserves the right to make changes or improvements in design and construction at any time, without incurring the obligation to make these changes on previously manufactured units.

TO THE OWNER:

Read this manual before using your Flip-Over Spike-Tooth Harrow. This manual is provided to give you the necessary operating and maintenance instructions for keeping your Spike-Tooth Harrow in top operating condition. Please read this manual thoroughly. Understand what each control is for and how to use it. Observe all safety signs on the machine and noted throughout the manual for safe operation of implement. Keep this manual handy for ready reference.

Like all mechanical products, it will require cleaning and upkeep.

Use only genuine Worksaver service parts. Substitute parts will void the warranty and may not meet standards required for safe and satisfactory operation. Record the model and serial number of your Harrow here:

Model: _____ Serial Number: _____

RETAIL CUSTOMER'S RESPONSIBILITY

It is the Retail Customer and/or Operator's responsibility to read the Operator's Manual, to operate, lubricate, maintain, and store the product in accordance with all instructions and safety procedures. Failure of the operator to read the Operator's Manual is a misuse of this equipment.

It is the Retail Customer and/or Operator's responsibility to inspect the product and to have any part(s) repaired or replaced when continued operation would cause damage or excessive wear to other parts or cause a safety hazard.

It is the Retail Customer's responsibility to deliver the product to the authorized Worksaver Dealer, from whom he purchased it, for service or replacement of defective parts which are covered by warranty. Repairs to be submitted for warranty consideration must be made within forty-five (45) days of failure.

It is the Retail Customer's responsibility for any cost incurred by the Dealer for traveling to or hauling of the product for the purpose of performing a warranty obligation or inspection.

LIMITED WARRANTY



Worksaver warrants to the original purchaser of any new Spike-Tooth Harrow Model FOH-5, that the equipment be free from defects in material and workmanship for a period of six (6) months for non-commercial, state, and municipalities. Use sixty (60) days for commercial use from date of retail sale.

Replacement or repair parts installed in the equipment covered by this warranty are warranted for sixty (60) days from the date of purchase of such part or to the expiration of the applicable new equipment warranty period, whichever occurs later.

Such parts shall be provided at no cost to the user during regular working hours. Worksaver reserves the right to inspect any equipment or parts which are claimed to have been defective in material or workmanship.

DISCLAIMER OF IMPLIED WARRANTIES & CONSEQUENTIAL DAMAGES

Worksaver's obligation under this warranty, to the extent allowed by law, is in lieu of all warranties, implied or expressed, including implied warranties of merchantability and fitness for a particular purpose and any liability for incidental and consequential damages with respect to the sale or use of the items warranted. Such incidental and consequential damages shall include but not be limited to: transportation charges other than normal freight charges; cost of installation other than cost approved by Worksaver; duty; taxes; charges for normal service or adjustments; loss of crops or any other loss of income; rental of substitute equipment, expenses due to loss, damage, detention or delay in the delivery of equipment or parts resulting from acts beyond the control of the manufacturer.

THIS WARRANTY SHALL NOT APPLY:

1. To vendor items which carry their own warranties, such as hydraulic cylinders, tires, and tubes.
2. If the unit has been subjected to misapplication, abuse, misuse, negligence, fire or other accident.
3. If parts not made or supplied by Worksaver have been used in connection with the unit, if, in sole judgement of Worksaver such use affects its performance, stability, or reliability.
4. If the unit has been altered or repaired outside of an authorized dealership in a manner which, in the sole judgement of Worksaver affects its performance, stability or reliability.
5. To normal maintenance service and normal replacement items such as gearbox lubricant, hydraulic fluid, worn blades, or to normal deterioration of such things as belts and exterior finish, due to use or exposure.
6. To expendable or wear items such as teeth, chains, sprockets, belts, springs and other items that in the company's sole judgement is a wear item.

NO EMPLOYEE OR REPRESENTATIVE OF WORKSAVER IS AUTHORIZED TO CHANGE THIS WARRANTY IN ANY WAY OR GRANT ANY OTHER WARRANTY UNLESS SUCH CHANGE IS MADE IN WRITING AND SIGNED BY WORKSAVER'S SERVICE MANAGER, POST OFFICE BOX 100, LITCHFIELD, ILLINOIS 62056-0100.



To the Owner/Operator/Dealer

All implements with moving parts are potentially hazardous. There is no substitute for a cautious, safe-minded operator who recognizes the potential hazards and follows reasonable safety practices. The manufacturer has designed this implement to be used with all its safety equipment properly attached to minimize the chance of accidents.

BEFORE YOU START!!

Read the safety messages on the implement and shown in your manual.
Observe the rules of safety and common sense!



THIS SYMBOL MEANS

- ATTENTION!
- BECOME ALERT!
- YOUR SAFETY IS INVOLVED!

THIS SAFETY ALERT SYMBOL IDENTIFIES IMPORTANT SAFETY WARNING MESSAGES. CAREFULLY READ EACH WARNING MESSAGE THAT FOLLOWS. FAILURE TO UNDERSTAND AND OBEY A SAFETY WARNING, OR RECOGNIZE A SAFETY HAZARD, COULD RESULT IN AN INJURY OR DEATH TO YOU OR OTHERS AROUND YOU. THE OPERATOR IS ULTIMATELY RESPONSIBLE FOR THE SAFETY OF HIMSELF, AS WELL AS OTHERS, IN THE OPERATING AREA OF THE TRACTOR AND ATTACHED EQUIPMENT.

UNDERSTAND SIGNAL WORDS

Note the use of the signal words **DANGER**, **WARNING** and **CAUTION** with the safety messages. The appropriate signal word for each has been selected using the following guidelines:

DANGER: Indicates an imminently hazardous situation that, if not avoided, will result in death or serious injury. This signal word is to be limited to the most extreme situations typically for machine components which, for functional purposes, cannot be guarded.

WARNING: Indicates a potentially hazardous situation that, if not avoided, could result in death or serious injury, and includes hazards that are exposed when guards are removed. It may also be used to alert against unsafe practices.

CAUTION: Indicates a potentially hazardous situation that, if not avoided, may result in minor or moderate injury. It may also be used to alert against unsafe practices.

If you have questions not answered in this manual or require additional copies or the manual is damaged, please contact your dealer or the manufacturer directly.

IMPORTANT SAFETY INFORMATION!

Working with unfamiliar equipment can lead to careless injuries. Read this manual, and the manual for your tractor, before assembly or operating, to acquaint yourself with the machines. It is the implement owner's responsibility, if this machine is used by any person other than yourself, is loaned or rented, to make certain that the operator, prior to operating:

1. Reads and understands the operator's manuals.
2. Is instructed in safe and proper use.



The use of this equipment is subject to certain hazards which cannot be protected against by mechanical means or product design. All operators of this equipment must read and understand this entire manual, paying particular attention to safety and operating instructions, prior to using. If there is something in this manual you do not understand, ask your supervisor, or your dealer, to explain it to you.

SAFETY INSTRUCTIONS (continued)



EQUIPMENT SAFETY GUIDELINES



Safety of the operator is one of the main concerns in designing and developing a new piece of equipment. Designers and manufacturers build in as many safety features as possible. However, every year many accidents occur which could have been avoided by a few seconds of thought and a more careful approach to handling equipment. You, the operator, can avoid many accidents by observing the following precautions in this section. To avoid personal injury, study the following precautions and insist those working with you, or for you, follow them.



Review the safety instructions with all users annually.



This equipment is dangerous to children and persons unfamiliar with its operation. The operator should be a responsible adult familiar with farm machinery and trained in this equipment's operations. **Do not allow persons to operate or assemble this unit until they have read this manual and have developed a thorough understanding of the safety precautions and of how it works.**



To prevent injury or death, use a tractor equipped with a Roll-Over Protective System (ROPS). Do not paint over, remove or deface any safety signs or warning signs on your equipment. Observe all safety signs and practice the instruction on them.



Never exceed the limits of a piece of machinery. If its ability to do a job, or to do so safely, is in question - **DON'T TRY IT.**



Do not modify the equipment in any way. Unauthorized modification may impair the function and/or safety and could affect the life of the equipment.



In addition to the design and configuration of this implement, including Safety Signs and Safety Equipment, hazard control and accident prevention are dependent upon the awareness, concern, prudence, and proper training of personnel involved in the operation, transport, maintenance, and storage of the machine. Refer also to Safety Messages and Operation Instructions in each of the appropriate sections of the Tractor and Implement Manuals. Pay close attention to the Safety Signs affixed to the Tractor and the Implement.



SAFETY SIGNS



Keep safety signs clean and legible at all times.



Replace safety signs that are missing or have become illegible.

















Replaced parts that displayed a safety sign should also display the current sign.



Safety signs are available from your Distributor or Dealer Parts Department or the factory.

SAFETY INFORMATION (continued)

-  All equipment is potentially hazardous. There is no substitute for a cautious, safe-minded operator who recognizes potential hazards and follows reasonable safety practices.
-  When the use of hand tools is required to perform any part of assembly, installation, adjustment, maintaining, repairing of the implement, be sure the tools used are designed and recommended by the tool manufacturer for that specific task.
-  Personal protection equipment including safety glasses, safety shoes, and gloves are recommended during assembly, installation, operation, adjustment, maintaining, repairing of the implement.
-  Always use two people to handle heavy, unwieldy components during assembly or installation of the implement.
-  Never place any part of your body where it would be in danger if movement should occur during assembly, installation, operation, maintaining, repairing of the implement.
-  Never place yourself between the tractor or ATV and implement while implement is in operation.
-  Harrow teeth are sharp! Do not allow harrow teeth to fall on any part of the body. Do not allow wrenches to slip when working near harrow teeth. Do not climb over machine above harrow teeth. Failure to stay clear of teeth can result in serious personal injury.
-  Never use alcoholic beverages or drugs which can hinder alertness or coordination while operating this equipment. Consult your doctor about operating this machine while taking prescription medications.
-  Do not allow others to ride on the tractor or ATV with an operator. Riders are subject to injury such as being struck by foreign objects or being thrown off. Riders obstruct the operator's view resulting in unsafe operation. **Never allow anyone to ride on the implement!**
-  Before you operate the equipment, check over all pins, bolts and connections to be sure all are securely in place. Replace any damaged or worn parts immediately.
-  Do not allow anyone who is not familiar with the safety rules and operation instructions to use this equipment.
-  Never allow children to operate or be around equipment.
-  Know your controls and how to stop tractor, engine, and implement quickly in an emergency. Read this manual and the one provided with your tractor.
-  Keep alert and watch the front as well as the rear when working with equipment.
-  Do not operate close to ditches or creeks. Slow down when operating over rough ground.

SAFETY INFORMATION (continued)



When maneuvering close to buildings or passing through narrow areas, be sure to allow sufficient clearance for the implement and tractor or ATV.



When removing, or adjusting equipment, be sure that your feet are never under the implement.



Be careful to avoid catching the implement on stumps or other immovable objects.



Use extra care when working on slopes.



Avoid excessive speed during operation.



Make implement adjustments only when the implement is attached to the tractor.



Always ease the tractor or ATV into the load.



Watch for and avoid hidden obstructions, i.e., buried pipes, rocks, concrete piers, uneven concrete slabs, stumps, etc., when operating equipment.



Never operate tractor and implement under trees with low hanging limbs. Operators can be knocked off the tractor and then run over by the implement.



Always be sure the implement is in the proper position for transport.



Reduce speed when transporting mounted implements to avoid bouncing and momentary loss of steering control.

















Be a safe and courteous driver. Always yield to oncoming traffic in all situations, including narrow bridges, intersections, etc.



Do not exceed 10 mph (16 kph). Reduce speed on rough roads and surfaces.

SAFETY INSTRUCTIONS (continued)

-  Be certain the tractor or ATV is in neutral or park position before starting engine.
-  Take all possible precautions when leaving unit unattended: Disengage PTO, set parking brake, stop engine and remove key from ignition. Park in level area.
-  Pick up all rocks and other debris before operation. Enter new areas carefully. Never assume an area is clear.
Always Check!
-  Turn curves or go up or down hills only at a low speed and at a gradual steering angle. Make certain that at least 20% of the tractor's weight is on the front wheels to maintain safe steering. Slow down on rough or uneven surfaces, and loose gravel.
-  Never work under equipment unless it is blocked securely.
-  Keep all persons away from operator control area while performing adjustments, service, or maintenance.
-  Never replace hex bolts with less than grade five bolts unless otherwise specified, i.e. shear bolts. Refer to bolt torque chart for head identification marking.
-  Where replacement parts are necessary for periodic maintenance and servicing, genuine factory replacement parts must be used to restore your equipment to original specifications. The manufacturer will not claim responsibility for use of unapproved parts and/or accessories and other damages as a result of their use.
-  If equipment has been altered in any way from original design, the manufacturer does not accept any liability for injury or warranty.
-  Following operation, or when unhooking, stop the tractor or ATV, set the brakes, shut off the engine and remove the ignition keys.
-  Store the unit in an area away from human activity. Do not park equipment where it will be exposed to livestock for long periods of time. Damage and livestock injury could result.
-  Do not permit children to play on or around the stored unit.
-  Make sure all parked machines are on a hard, level surface and engage all safety devices.
-  If blocking is used, make sure it is solid and secure before leaving area.

SAFETY SIGNS

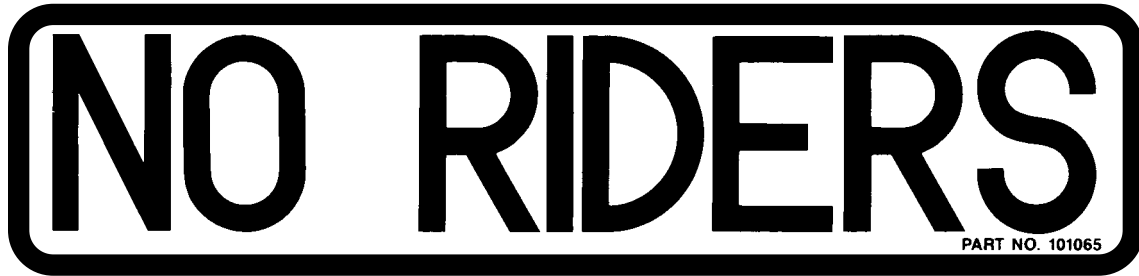

- ✓ Keep children away from danger all day, every day.
- ✓ Please work, drive, play, and live each day with care and concern for your safety and that of your family and fellow citizens.

**OBHEY ALL
SAFETY WARNINGS!!**

INSTRUCTIONS

TRACTOR/ATV REQUIREMENTS AND PREPARATION

The model FOH-5 spike-tooth harrow is designed for 16 hp or larger garden tractors and ATV's with an engine size of 250 cc or more.

The harrow is easy to pull and maneuver. It can be turned in tight areas.

The harrow is easily flipped over so it can be transported over lawns or driveways without tearing up the surface.

NOTE: The transport wheels are for use behind the tractor or ATV only. They are **NOT** designed for road use.

Adjustable spike-tooth harrows do an excellent job of smoothing garden plots, fields, arenas, and landscaping. Harrows will spread manure droppings, grass clippings, leaf litter, and previous crop stubble.

Spike harrows will incorporate fertilizers, herbicides, and broadcasted seed into the soil. They will also remove ridges left by plowing implements and loosen crusted soil.



Be sure your tractor or ATV is in good condition. Read all the safety precautions and make sure all operators are familiar with the safety rules of operation.

PACKAGING

The model FOH-5 harrow is normally shipped on a single pallet. The harrow section is pre-assembled. The rear part of the main frame will have the wheels installed. The other frame parts will be strapped together. The hardware will be in a box along with the operator's manual.

ASSEMBLY

Preview the assembly instructions and the exploded view of the harrow in your operator's manual and become familiar as to how the parts or assemblies go together.

Select an area for assembly that is clean and free from debris.

Do not attempt to lift heavy parts or assemblies. Use a hoist, crane, forklift, or similar safe mechanical device, or another person.

Stand to the side and cut the shipping bands using a pair of sheet metal shears. Remove the parts from the pallet. Open the box containing the hardware and operator's manual.

Lay the harrow section on a flat surface with the spike-teeth down. Position the rear part of the main frame at the rear of the harrow section (as shown in the exploded parts diagram) and install the two $\frac{3}{8}$ " x $1\frac{1}{2}$ " bolts, washers, and nylock nuts as shown.

Place the front main frame crosstube assembly at the front of the harrow section and install the two $\frac{5}{8}$ " x $2\frac{1}{4}$ " bolts, washers, and nylock nuts as shown. Make sure you have a flat washer on each side of both of the harrow section side bars.

Lay the two front to rear angle iron bars onto the harrow section. These bars go under both the front and rear crosstube frames and are just outside the front pull bracket assembly. They attach to the front and rear crosstubes with the $\frac{5}{16}$ " x 2" square u-bolts.

Position the tongue weldment between the front pull brackets welded to the front crosstube. Install the two $\frac{5}{8}$ " x $1\frac{1}{2}$ " bolts with washers and nylock nuts as shown in the exploded parts diagram.

NOTE: Nylock nuts are used at locations where some pivoting motion is expected between the bolted parts. It is suggested that nylock nuts be tightened to just a snug fit and then backed off 1 - $1\frac{1}{2}$ turns.

Install the two $\frac{1}{2}$ " x $3\frac{1}{2}$ " shift pins to lock the tongue weldment to the front crosstube pull brackets. (This is the position of the pins for transport and to flip the harrow over.) Install the hairclip pins in the ends of the $\frac{1}{2}$ " x $3\frac{1}{2}$ " shift pins.

NOTE: The two $\frac{1}{2}$ " x 3" shift pins need to be removed from the crosstube pull brackets for harrowing. This allows the tongue assembly to float. The pins can be stored by locking them in the two inside brackets on the tongue assembly (see lower part of FIG. A).

INSTRUCTIONS (continued)

FLIPPING THE HARROW FROM HARROWING TO TRANSPORT POSITION AND VISE VERSA

Pull the harrow to a level location. Unhook the harrow from the tractor or ATV drawbar and move the tractor/ATV out of the way. (FIG. E)

Install the two $\frac{1}{2}$ " x $3\frac{1}{2}$ " shift pins to lock the tongue assembly in the ridged position (pins go from outside toward the center). (Top part of FIG. A)

With the handle on the harrow, adjust the harrow teeth to an almost flat position (handle forward). (FIG. B)

Lift the harrow tongue and raise the harrow to a vertical position. The harrow should be able to stand alone in a vertical position while you walk around to the other side of the harrow. (FIG. C)

Reach up and grab the harrow tongue and gently pull the tongue toward you. Remember as the tongue comes toward you, on the "wheel side" of the harrow, it may require placing one foot on the rear crosstube as you pull the tongue downward. You will be taking more of the weight of the harrow as the harrow lowers. (FIG. D)

Once the harrow is flipped over and horizontal on the ground, back your tractor or ATV up to the tongue and reconnect to the unit.



Do not leave the harrow in a vertical position. The harrow could fall over and hurt someone. If you are placing the harrow in a vertical position for storage, secure the harrow so it cannot fall over.

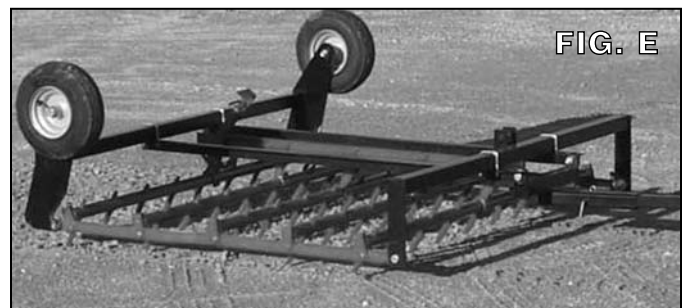
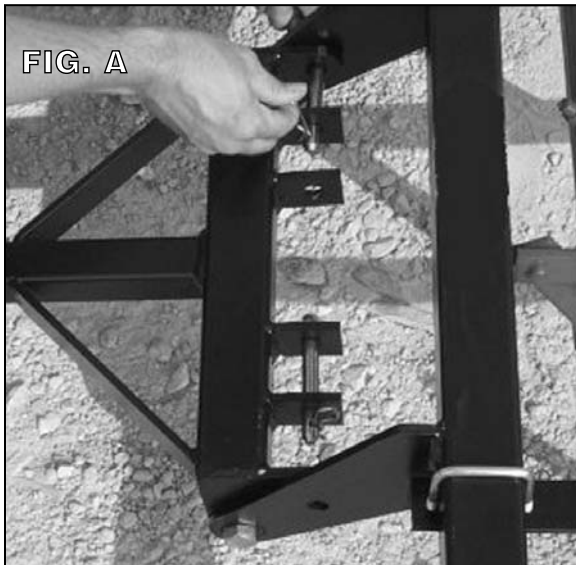
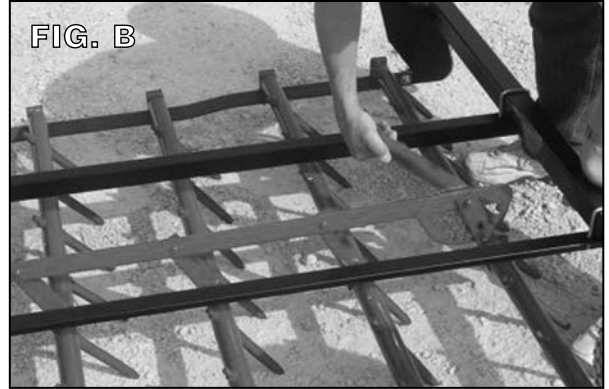

OPERATING INSTRUCTIONS

OPERATION

The safe operation of the implement is the responsibility of the operator. The operator should be familiar with the implement, tractor (or ATV) and all safety practices before starting operation. Review and follow all the safety rules in this manual and those of the tractor or ATV.

A responsible adult (not a child) should do all the harrowing and transporting operations.

Inspect the area to be harrowed for stumps, stones, branches, or other foreign objects that could cause damage to the pulling vehicle or the harrow. If objects cannot be cleared from the area (like stumps) then mark them clearly so the operator can avoid them.

The model FOH-5 spike-tooth harrow has adjustable tooth angle. This allows you to set the teeth at 6 different angles to provide the best flow-through of residue (flat-test tooth angle) or the most aggressive tooth position for fluffing up an arena (most straight up and down tooth angle) and every position in between to fit the job you need to do.

The model FOH-5 harrow has a staggered tooth arrangement to give maximum conditioning of the soil, breaking up and spreading of manure and residue, and for even leveling and firming of the soil.

The spike-tooth harrow will cut trash and penetrate the soil for good ground preparation. In tough soil conditions, several passes may be necessary to work the soil to a satisfactory condition.

The harrow can be operated at up to 5 mph. Under most conditions, 3 to 4 mph is a better operating speed. Operating too fast will not allow the teeth to penetrate and greatly increase the chance of damage to the harrow.

In most cases, multiple passes will be required to achieve the desired soil preparation. It is recommended to straddle previous passes or work the second time over at an angle to avoid ridging and to mix the soil.

Never allow anyone to play near the unit and always store the unit in a safe secure place, preferable in a locked storage shed or fenced area. Never allow anyone to climb or ride on the unit for any reason.

UNEVEN TERRAIN –



Do not operate on steep slopes.

Do not stop, start or change directions suddenly on slopes.

Use extreme care and reduce ground speed on slopes and rough terrain.

Watch for hidden hazards on the terrain during operation.

Pass diagonally through sharp dips and avoid sharp drops to prevent “hanging up” tractor and harrow.

Practice will improve your skills in maneuvering rough terrain.



Keep alert and watch the front as well as the rear when working with equipment.

Do not operate close to ditches or creeks.

Slow down when operating over rough ground. Avoid excessive speeds!



When maneuvering close to buildings or passing through narrow areas, be sure to allow sufficient clearance for the implement and tractor or ATV.



**SAFETY . . .
YOU CAN LIVE WITH IT!**

OWNER SERVICE

The information in this section is written for operators who possess basic mechanical skills. For your protection, read and follow all safety information in this manual.

WARNING!

Always stop the tractor or ATV, set brake, shut off engine, and remove key before attempting to service. Never leave equipment unattended with engine running.

MAINTENANCE

Periodically check all bolts to make sure they are properly tightened. Remember that bolts with nylock lock nuts are pivot points and the nut should be tightened so that the parts can still pivot freely.

NOTE: The nylon plastic ring in the domed head of a nylock nut must fully engage the threads of the bolt to “lock” the nut in position.

Harrow tooth nuts and the nuts on the 2” u-bolts should be fully tightened.

Replace any worn or damaged parts immediately.

STORAGE

At the end of the working season or when the harrow will not be used for a long period, it is good practice to clean off any dirt that may have accumulated on the implement and any of the moving parts.

Inspect the harrow for loose, damaged or worn parts and adjust or replace if needed.

Repaint parts where paint is worn or scratched to prevent rust. Replace any safety signs if damaged or missing.

CAUTION!

Do not leave the harrow in a vertical position. The harrow could fall over and hurt someone. If you are placing the harrow in a vertical position to save space for storage, secure the harrow so it cannot fall over.

CAUTION!

Always store harrow with the harrow teeth in a flat position so there are not sharp points protruding out or up.

Store the unit in a shed or under a tarpaulin to protect it from the weather. The harrow teeth and tires should rest on boards, or some other object, to keep them out of the soil.

Store harrow in a clean, dry place away from human activity or pets and livestock.

Never allow anyone to play near the unit and always store the unit in a safe secure place, preferable in a locked storage shed or fenced area. Never allow anyone to climb or ride on the unit for any reason.

**ALWAYS
OBEY ALL
SAFETY
WARNINGS!!**

FOH-5 PARTS DRAWING

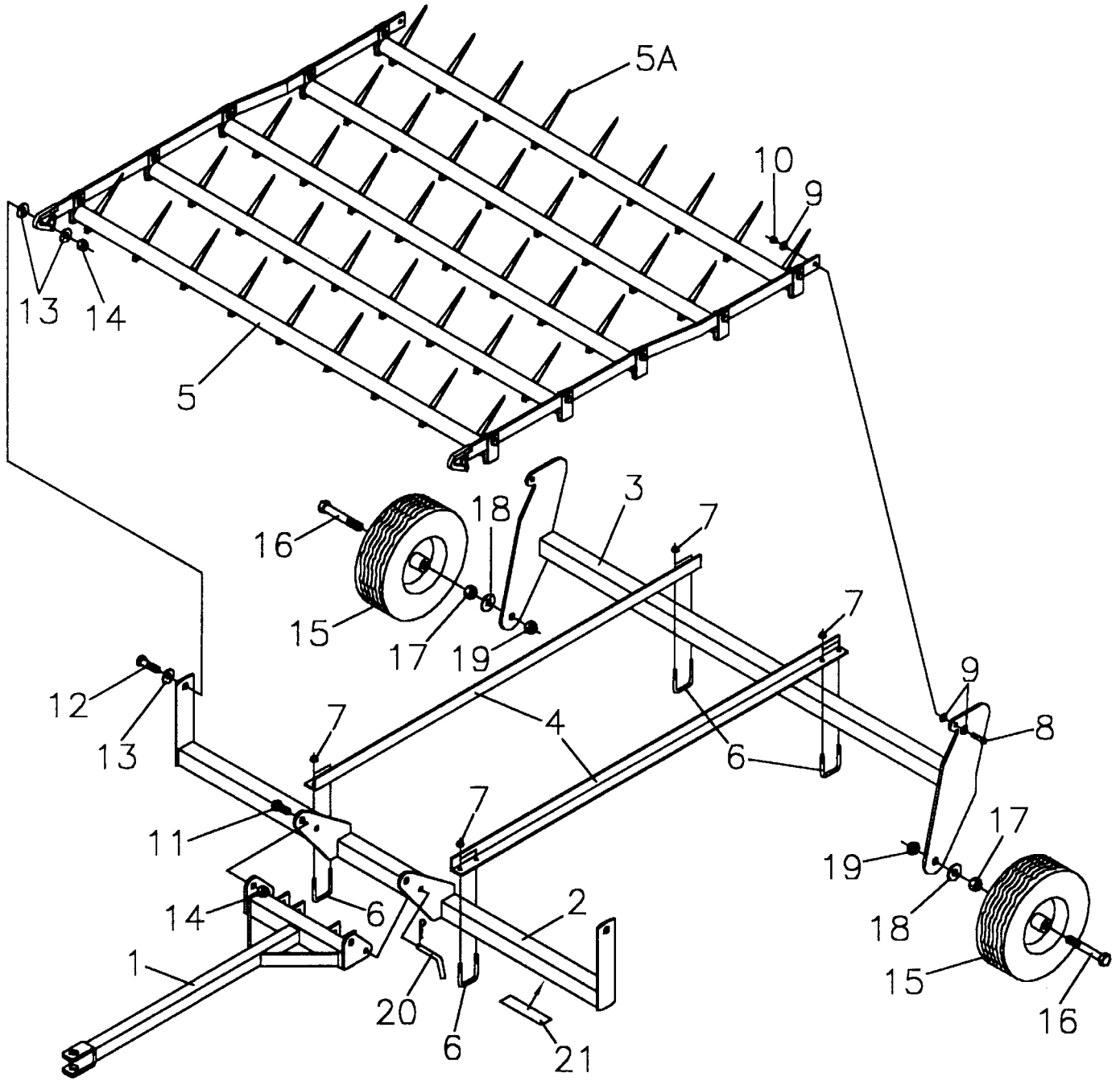

FOH-5 PARTS LIST

Ref. No.	Part No.	Description	No. Req'd.
1	940505	Tongue Weldment	1
2	940510	Tongue Mount Weldment	1
3	940515	Wheel Mount Weldment	1
4	940513	Tie Angle	2
5	940520	5 Ft. Harrow Section	1
5A	940501	Tooth, Spike Harrow	42
6	2503293	U-Bolt 5/16"-18NC	4
7	2500060	Nut 5/16"-18NC Whiz Flange Hex	8
8	2503006	Bolt 3/8"-16NC x 1 1/2" Hex Head Gr. 2	2
9	2501004	Washer 3/8" Flat	6
10	2500042	Nut 3/8"-16NC Nylock Hex	2
11	2503047	Bolt 5/8"-11NC x 1 1/2" Hex Head Gr. 2	2
12	2503059	Bolt 5/8"-11NC x 2 1/4" Hex Head Gr. 2	2
13	2501005	Washer 5/8" Flat	6
14	2500041	Nut 5/8"-11NC Nylock Hex	4
15	341935	Wheel Assembly 410/350 x 6	2
16	2503033	Bolt 3/4"-10NC x 5" Hex Head Gr. 2	2
17	2500002	Nut 3/4"-10NC Full Hex	2
18	2501002	Washer 3/4" Flat	2
19	2500075	Nut 3/4"-10NC Nylock Hex Jam	2
20	341857	Shift Pin 1/2" x 3 1/2" w/Hairpin Clip	2
21	101065	Safety Sign-No Riders	1

⚠ SAFETY PRECAUTIONS ⚠

**MOST ACCIDENTS OCCUR BECAUSE OF NEGLIGENCE OR CARELESSNESS.
AVOID NEEDLESS ACCIDENTS BY FOLLOWING ALL OF THE SAFETY PRECAUTIONS LISTED BELOW.**

- Machinery should be operated only by those who are responsible and are authorized to do so.
- Stop the engine, lower all equipment, lock the brakes, and remove the ignition key before dismounting from the tractor.
- Never stand between tractor and implement while tractor is being backed to hitch.
- Loose fitting clothing should not be worn, to avoid catching on various parts.
- Detach implement in area where children normally do not play.
- When performing adjustments or maintenance on an implement, first lower it to the ground or block it securely at a workable height.
- Only a qualified operator should be permitted on tractor when in operation; no riders allowed.
- Make certain everyone is in the clear before starting tractor or raising or lowering equipment.
- Operate the tractor and implement only while seated in the driver's seat.
- Reduce speed when transporting mounted implements to avoid bouncing and momentary loss of steering control.
- A heavy load can cause instability of the tractor. Use extreme care during road travel. Slow down on turns and watch out for bumps. Tractor may need front counterweights to counter-balance the weight of the implement.
- Reduce speed on hillsides or curves so there is no danger of tipping.
- Avoid driving too close to the edge of ditches or creeks.
- Do not transport implement on public roads without reflectors and slow moving vehicle emblem in daylight and with approved warning lights at night and other periods of poor visibility.
- Due to the width of some implements, use extra caution on highways, farm roads, and when approaching gates.
- Always be sure the implement is in the proper position for transport.
- Keep alert and watch the front as well as the rear when working with the implement.

OWNER'S/ OPERATOR'S MANUAL

**MODEL NO.
FOH-5**

**WHEN ORDERING
REPAIR PARTS,
ALWAYS GIVE
THE FOLLOWING
INFORMATION:**

1. PART NUMBER
2. PART DESCRIPTION
3. MODEL NUMBER
4. NAME OF ITEM

JULY 2002

FLIP-OVER SPIKE-TOOTH HARROW

**Keep children away from danger all day,
every day . . .**

**Please work, drive, play and live each day
with care and concern for your safety and
that of your family and fellow citizens.**

**MAKE EVERY DAY
A HOLIDAY
FROM ACCIDENTS!**

WORKSAVER, INC.

P.O. BOX 100 LITCHFIELD, IL 62056-0100 (217) 324-5973
WEB: <http://www.worksaver.com> E-MAIL: sales@worksaver.com